



Vegetable Preparation Machine

RG-200

Food Preparation Machines - Made in Sweden 



7 kg
/min

700
/day



halde.com

Size that matters and quality

The RG-200 is designed to suit the kitchen with smaller volumes but needs the quality and power of a large professional vegetable preparation machine. The size makes the machine suitable to use directly on a kitchen workbench.

Ergonomics and safety at all levels

Thanks to the automatic start and stop function the machine stops as soon as the pusher plate is swung aside. When it is swung back the machine restarts and you can continue working. If the feed cylinder is removed the power is cut. The RG-200 also has a full moon cylinder that can hold larger quantities and whole products. Features like these are a clear advantage, particularly when larger volumes are involved.

The leaning design means that the feed cylinder is always positioned at the right angle making it easy to top up. It does not take up a lot of space in the kitchen. You can use it as a table top machine. And it is easy to move, something which is helped by the generously sized handle on the back.

Easy cleaning for the best hygiene

For quick cleaning, all loose parts are simple to remove for easy rinsing of the machine. The feed cylinder is removable and can be cleaned under running water.

The RG-200 is manufactured solely from hygiene certified material. The machine has smooth surfaces, rounded edges and has no unnecessary recesses where food might penetrate and get stuck.

Highest possible reliability

The powerful motor has a high starting and running torque and powers the direct-driven cutting tool. This makes the RG-200 an exceptionally reliable machine – irrespective of the products you are preparing.

Cutting tools with complete register

Our wide range of Ø185 mm cutting tools means the RG-200 can handle every conceivable task. The RG-200 slices, dices, shreds, grates, cuts juliennes and crimping slices – everything from firm to soft products. The knife blades and grating plates are replaceable so you can easily maintain a sharp edge on the cutting tools.

Always perfect cutting results

The rotation speed of the cutting tools is optimised for cutting fine and even slices as efficiently as possible. The knife blades are purposefully sharpened to keep a sharp edge for as long as possible.

Accessories that simplify life in your kitchen

• Angle Cut Feed Head

Used for slicing long and narrow vegetables such as cucumbers, carrots and leeks to get angled decorative slices for wok dishes, sandwiches, salads etc.



• Pipe insert incl. Pestle

Used for continuous feeding of long and thin vegetables that are to be cut "standing", for example spring onion, chilli and radish. The pipe insert is placed in the inbuilt tube feeder.



• Machine table for a better ergonomomy

The table can be set at three different heights (high, medium, low) so that correct ergonomic posture is always guaranteed. The design of the table allows easy accommodation of HALLDE's Container Trolley.



• Container Trolley for a smooth flow

Facilitates the handling of cut products, transporting them easily to subsequent stages of the preparation process. Can be adjusted to different heights and even folded up completely. The trolley is made entirely of stainless steel, with four sturdy wheels, two of which are lockable.



• Cleaning brushes in two sizes

Used for cleaning machines and cutting tools. Both have coarse bristles that are particularly effective for cleaning Dicing Grids and Julienne Cutters.























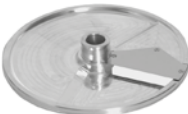













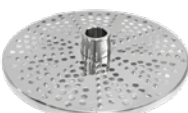

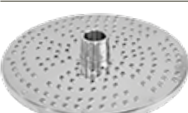

• Wall rack for Cutting Tools

Provides space for three cutting tools and a quick overview of the entire range, saving space and making handling safe and comfortable – an effective way of protecting the edges of the blades from unnecessary wear.

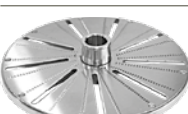

High quality cutting tools for best results

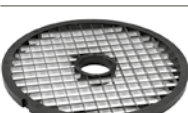
All cutting tools are dishwasher safe.  Replaceable knives / plates.  = Stainless steel.

| | | | |
|---|--|--|---|
|  | <p>Slicers </p> <p> 0.5, 1, 1.5, 2, 3, 4, 5, 6, 7, 8, 9, 10 mm</p> | <p>Slices firm and soft vegetables, fruits, mushrooms etc. Dices when combined with a suitable Dicing Grid. Cuts potato chips in combination with Potato Chip Grid.</p> |  |
|  | <p>Standard Slicer</p> <p> 20 mm</p> | <p>Slices firm products, such as root vegetables etc. Dices when combined with a suitable Dicing Grid.</p> |  |
|  | <p>Fine Cut Slicer</p> <p> 15 mm</p> | <p>Slices firm and soft vegetables, fruits, mushrooms etc. Dices when combined with a suitable Dicing Grid.</p> |  |
|  | <p>Soft Slicers</p> <p> 8, 10, 12, 15 mm</p> | <p>Slices soft vegetables, fruits, mushrooms etc. Preferably used when dicing soft products, in combination with a suitable Dicing Grid.</p> |  |
|  | <p>Crimping Slicers </p> <p> 2, 3, 4, 5, 6 mm</p> | <p>Cuts decorative rippled slices of beetroot, cucumber, carrots, etc.</p> |  |
|  | <p>Julienne Cutters </p> <p> 2x2, 2x6, 3x3, 4x4, 6x6, 8x8, 10x10 mm</p> | <p>Cuts julienne of firm products for soups, salads, stews, decorations etc. Suitable to cut slightly curved potatoes chips.</p> |  |
|  | <p>Grater/Shredders </p> <p> 1.5, 2, 3, 4.5, 6, 8, 10 mm</p> | <p>Grates carrots and cabbage for raw salads. Grates nuts, almonds and dry bread. Grater 6 or 8 mm is commonly used for grating cheese for pizza and when shredding cabbage.</p> |  |
|  | <p>Fine Grater </p> <p></p> | <p>For finely grating products such as raw potatoes for Swedish potato pancakes and bread for making breadcrumbs.</p> |  |
|  | <p>Hard Cheese Grater </p> <p></p> | <p>Ideal for grating hard cheese such as parmesan. Produces a somewhat coarser grate than the Fine Grater, Extra fine.</p> |  |
|  | <p>Fine Grater, Extra fine </p> <p></p> | <p>Grates products very finely, such as black radish grated for purée and potatoes for mashing.</p> |  |
|  | <p>Dicing Grid </p> <p>6x6, 8x8, 10x10, 12x12, 15x15, 20x20 mm</p> | <p>Cuts dices in combination with a suitable type of Slicer. Dice both hard and soft vegetables, fruits etc.</p> |  |

Take a look at the results- and inspiration videos at our homepage, hallde.com →





Machine

- Motor: 0.25 kW. One-speed.
100 V, single phase, 50-60 Hz. 110-120 V, single phase, 60 Hz.
220 V, single phase, 50 Hz. 230-240 V, single phase, 50 Hz.
230 V, three phase, 50 Hz. 400 V, three phase, 50 Hz.
440 V, three phase, 60 Hz.
- Transmission: Planetary gearing.
- Safety system: Two safety switches.
- Degree of protection machine: IP44.
- Degree of protection push buttons: IP65.
- Power supply socket: Earthed, single phase, 10 A.
- Fuse: 10 A, delayed action fuse.
- Sound level LpA (EN31201): 73 dBA.
- Magnetic field: Less than 0.5 microtesla.

Materials

- Machine housing: Anodized and polished aluminium alloy.
- Ejector plate: Acetal
- Cutting tool discs: Stainless steel/ Aluminium/ Fiberglass reinforced polyamide
- Cutting tool knife blades: Stainless knife steel.
- Machine table: Stainless steel.
- Container: Polycarbonate.

Feeder

- Feed cylinder: Volume 3 litre. Height 185 mm. Diameter 170 mm.
- Feed tube with internal diameter 56 mm.

Cutting tools

- Diameter: 185 mm.
- Speed: 350 rpm (50 Hz), 420 rpm (60 Hz).

Type of preparation

- Slices, dices, grates, shreds, cuts julienne and crimping slices.
- Processes vegetables, fruit, dry bread, cheese, nuts, mushrooms, etc.

Users

- Restaurants, shop kitchens, diet kitchens, retirement homes, hospitals, schools, fast food outlets, catering, day care centres, salad bars, pizzerias, ships, etc.

Net weights

- Machine: 18,6 kg.
- Cutting plates: 0.55 kg.

Standards

- Directive: Visit Hallde.com and select product and certification.

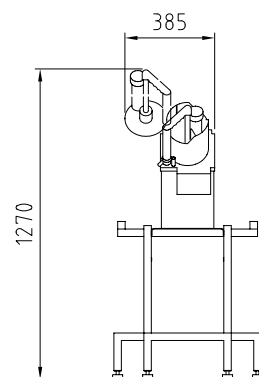
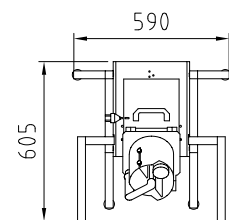
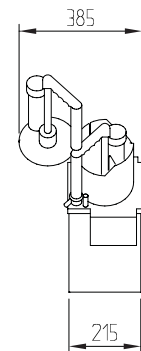
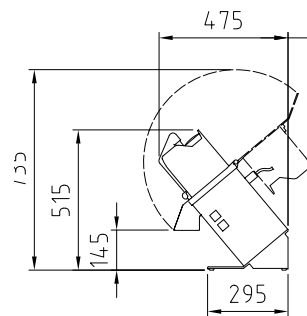

Food Preparation Machines
Made in Sweden since 1941

AB Hallde Maskiner – P.O. Box 1165 SE-164 26 Kista Sweden
• Phone: +46 8 587 730 00 • Fax: +46 8 587 730 30 • hallde.com • info@hallde.com

We reserve the rights to make changes in design and product range without notice

© AB Hallde Maskiner 2023