



Girarrosti planetari elettrici
 Electrical planetary chicken-spits
 Rôtissoires planétaires électriques
 Elektro-Hähnchengrillgeräte mit Planetengetriebe
 Asadores planetarios eléctricos

Serie
 Line
 Série
 Modell
 Serie

Cod. 14100078 - P7/5 (20P)*



Nr. 20



Nr. 5

P7/5 (20P)

Caratteristiche e vantaggi

- Movimento planetario con asta centrale
- Tecnologia di cottura con resistenze corazzate
- Apertura con vetro a sollevamento verticale con circolazione naturale dell'aria
- Ottima visibilità e presentazione dei prodotti durante la cottura - dotati anche di vetro posteriore
- Bacinella d'appoggio estraibile

Characteristics and advantages

- Planetary movement with central spit
- Cooking technology with sheathed heating elements
- Vertical glass lifting opening with natural air circulation
- Excellent visibility and presentation of the products during cooking process - also equipped with rear glass
- Removable working shelf

Caractéristiques et avantages

- Mouvement planétaire avec broche centrale
- Technologie de cuisson avec des résistances blindées
- Ouverture avec vitre à levage vertical et avec circulation naturelle de l'air
- Excellente visibilité et présentation des produits pendant la cuisson - équipés aussi de vitre à l'arrière
- Bac d'appui amovible

Merkmale und Vorteile

- Planetengetriebe mit zentraler Stange
- Kochsystem mit Heizstäben
- Vertikale Glasöffnung mit natürlicher Luftzirkulation
- Hervorragende Sichtbarkeit und Präsentation der Produkte während des Kochens - auch mit rückwärtigem Glas ausgestattet
- Abnehmbare Ablagefläche

Características y ventajas

- Rotación planetaria y barra central
- Tecnología de cocción por resistencias acorazadas
- Apertura con cristal de elevación vertical y circulación natural del aire
- Excelente visibilidad y presentación de los productos durante la cocción - también equipados con vidrio trasero
- Bandeja de soporte extraíble



- * Schidioni completi di forchette in dotazione
- * Complete spits with forks included
- * Broches dotées de fourchettes en dotation
- * Inklusive Spieße mit Klammern
- * Espadas con pinchos incluidas

Funzionamento



How to use it



Utilisation



Funktion



Funcionamiento





P7/5 (20P)

Schidioni
Spits
Broches
Spieße
Espadas

Schidione completo di forchette
Complete spit with forks
Broche complète de fourchettes pour poulets
Spieß mit Klammern
Espada dotada de pinchos

Schidione rapido per polli
Quick spit for chicken
Broche rapide pour poulets
Schneller Spieß für Hähnchen
Espada rápida para pollos

Schidione gabbia bombata
Convex cage grid
Broche cage bombée
Gewölbter Butterfly-Flachkorb
Espada caja convexa

Schidione a cestello chiuso
Closed basket grid
Balancelle panier fermé
Geschlossener Hängekorb
Cesta cerrada

Coppia di forchettoni
Clamps set
Set outillages grosse pièce
Gabelset
Set pinchos



Schidione a forchetta lunga
Special long spit
Broche deux piques pour poulets
Langer Spieß für Hähnchen
Espada de pincho largo

Schidione gabbia piatta
Flat cage grid
Broche cage plate
Butterfly-Flachkorb
Espada caja plana

Schidione per arrosto
Grid for roast
Broche pour rôti
Spießkorb für Braten
Espada para asado

Cestello a rete
Basket grid
Balancelle à cage
Hängekorb
Cesta enrejada

Coppia di forchettoni per asta centrale
Clamps set for central tool
Set outillages centrales grosse pièce
Gabelset für Spanferkel
Set pinchos para barra central

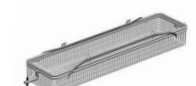

Info tecnica
Technical info
Infos techniques
Technische Info
Info técnica

Tipo presa Socket Prise Anschlussdose Toma de enchufe	16 A
Collegamento elettrico Electrical connection Connexion électrique Elektrische Anschlüsse Conexión eléctrica	Corrente max. 11 A Max. Voltage 11 A Courant max. 11 A Max. Strom 11 A Voltaje máx. 11 A
Cavi di alimentazione Power Cables Câbles d'alimentation Stromkabel Cables de alimentación	1

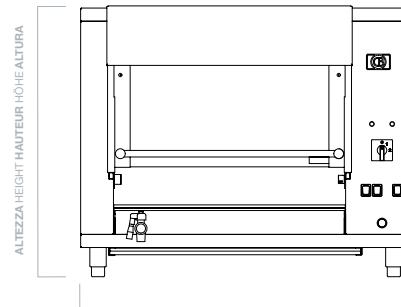

ALTEZZA HEIGHT HAUTEUR HÖHE ALTURA

LARGHEZZA WIDTH LARGEUR BREITE ANCHURA

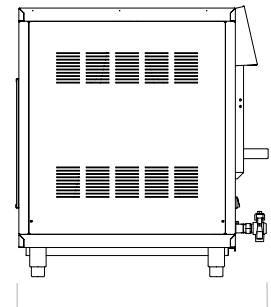

PROFONDITÀ DEPTH PROFONDEUR TIEFE PROFUNDIDAD

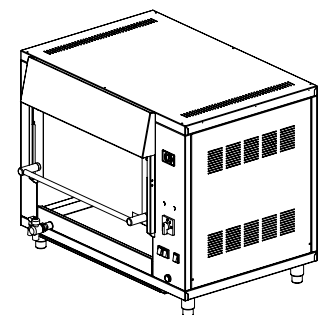
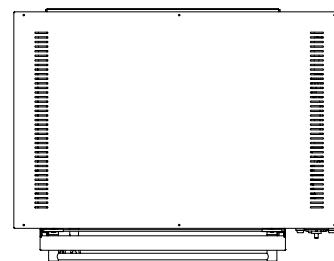

Attenzione: Mantenere una distanza di almeno 150 mm dalle pareti
Attention: Maintain a distance of at least 150 mm from the walls
Attention: Maintenez une distance d'au moins 150 mm des murs
Achtung: Abstand von mindestens 150 mm zu den Wänden einhalten
Atención: mantenga una distancia de al menos 150 mm de las paredes

Modello Model Modèle Modell Modelo	Aste Spits Broches Spieße Espadas	Polli Chickens Poulets Hähnchen Pollos	Larghezza Width Largeur Breite Anchura	Profondità Depth Profondeur Tiefe Profundidad	Altezza Height Hauteur Höhe Altura	Altezza con vetro alzato Height with lifted glass Hauteur avec vitre soulevée Höhe mit Scheibe oben Altura con cristal elevado	Tensione Voltage Tension Spannung Voltaje	Potenza Power Puissance Leistung Potencia	Peso Weight Poids Gewicht Peso
P7/5 (20P)	5	20(20 Kg)	1008 mm	660 mm	820 mm	870 mm	230V 3~/400V 3N~	7,7 KW	Kg 106