



Girarrosti a gas ad aste singole sovrapposte

Gas chicken-spits with overlapped single spits

Rôtissoires à gaz à broches indépendantes et superposées

Gas-Hähnchengrillgeräte mit einzelnen vertikal angeordneten Spießen

Asadores de gas con espadas individuales superpuestas

Serie
Line
Série
Modell
Serie

Cod. 14100375 - G-20P*



Nr. 20



Nr. 5



G-20P

Caratteristiche e vantaggi

- Movimento ad aste singole sovrapposte
- Tecnologia di cottura con bruciatori ad infrarossi e rubinetto valvolato con termocoppia di sicurezza
- Apertura con vetro a sollevamento verticale
- Circolazione naturale dell'aria

Characteristics and advantages

- Movement with single overlapping spits
- Cooking technology with infrared burners and valve with safety thermocouple
- Opening with vertical lifting glass
- Natural air circulation

Caractéristiques et avantages

- Mouvement à broches indépendantes et superposées
- Technologie de cuisson avec brûleurs à infrarouges et robinet à valve avec thermocouple de sécurité
- Ouverture avec vitre à levage vertical
- Circulation naturelle de l'air

Merkmale und Vorteile

- Einzelspieß-Drehbewegung, übereinander angeordnet
- Kochsystem mit Infrarotbrennern und Ventil mit Sicherheitsthermoelement
- Vertikale Glasöffnung
- Natürlicher Luftzirkulation

Características y ventajas

- Rotación de espadas individuales superpuestas
- Tecnología de cocción por quemadores de infrarrojos, grifo con válvula y termopar de seguridad
- Apertura con cristal de elevación vertical
- Circulación natural del aire

* Schidioni completi di forchette in dotazione

* Complete spits with forks included

* Broches dotées de fourchettes en dotation

* Inklusive Spieße mit Klammern

* Espadas con pinchos incluidas

Funzionamento



How to use it



Utilisation



Funktion



Funcionamiento





G-20P

Schidioni
Spits
Broches
Spieße
Espadas

Schidione completo di forchette
Complete spit with forks
Broche complète de fourchettes pour poulets
Spieß mit Klammern
Espada dotada de pinchos

Schidione rapido per polli
Quick spit for chicken
Broche rapide pour poulets
Schneller Spieß für Hähnchen
Espada rápida para pollos

Schidione gabbia bombata
Convex cage grid
Broche cage bombée
Gewölbter Butterfly-Flachkorb
Espada caja convexa

Schidione a cestello chiuso
Closed basket grid
Balancelle panier fermé
Geschlossener Hängekorb
Cesta cerrada

Schidione per porchetta
Spit for roast pig
Broche grosse pièce
Spieß für Spanferkel
Espada para lechón



Schidione a forchetta lunga
Special long spit
Broche deux piques pour poulets
Langer Spieß für Hähnchen
Espada de pincho largo

Schidione gabbia piatta
Flat cage grid
Broche cage plate
Butterfly-Flachkorb
Espada caja plana

Schidione per arrosto
Grid for roast
Broche pour rôti
Spießkorb für Braten
Espada para asado

Cestello a rete
Basket grid
Balancelle à cage
Hängekorb
Cesta enrejada

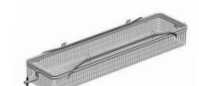

Info tecnica
Technical info
Infos techniques
Technische Info
Info técnica

Tipo presa Socket Prise Anschlussdose Toma de enchufe	Schuko	
Collegamento elettrico Electrical connection Connexion électrique Elektrische Anschlüsse Conexión eléctrica	Corrente max. 0,8 A Max. Voltage 0,8 A Courant max. 0,8 A Max. Strom 0,8 A Voltaje máx. 0,8 A	
Cavi di alimentazione Power Cables Câbles d'alimentation Stromkabel Cables de alimentación	1	
Tipo gas: Metano (Hi=9,45 KWh/mc) m³/h Type of gas: Natural gas H Type de gaz: Gaz naturel E+ Tipo de gas: Metano	Portata nominale 0,95 Rated heat input 0,95 Débit nominal 0,95 Alcance nominal 0,95	Portata del minimo 0,53 Min. heat input 0,53 Débit réduit 0,53 Alcance minimo 0,53
Ugelli: Metano 20 mbar (Ø in 1/100 mm) Injectors: Natural gas H Gicleurs: Gaz naturel E+ Boquillas: Metano	Portata nominale 220 Rated heat input 220 Débit nominal 220 Alcance nominal 220 Bruciatore pilota 35 Pilot burner 35 Brûleur pilote 35 Quemador piloto 35	Portata del minimo 250 Min. heat input 250 Débit réduit 250 Alcance minimo 250
Tipo gas: G.P.L. (Hi=12,68 KWh/kg) kg/h Type of gas: LPG Type de gaz: Gaz liquide Tipo de gas: G.P.L.	Portata nominale 0,71 Rated heat input 0,71 Débit nominal 0,71 Alcance nominal 0,71	Portata del minimo 0,39 Min. heat input 0,39 Débit réduit 0,39 Alcance minimo 0,39
Ugelli: G.P.L. 29/37 mbar (Ø in 1/100 mm) Injectors: LPG Gicleurs: Gaz liquide Boquillas: G.P.L.	Portata nominale 150 Rated heat input 150 Débit nominal 150 Alcance nominal 150 Bruciatore pilota 20 Pilot burner 20 Brûleur pilote 20 Quemador piloto 20	Portata del minimo 140 Min. heat input 140 Débit réduit 140 Alcance minimo 140
Distanza X aria primaria X distance of primary air Distance X air primaire Distancia X para aire primario	Metano: chiusa Natural gas H: close Gaz naturel E+: fixe Metano: cerrado	G.P.L.: 4 LPG: 4 Gaz liquide: 4 G.P.L.: 4

Attenzione: Mantenere una distanza di almeno 150 mm dalle pareti
Attention: Maintain a distance of at least 150 mm from the walls
Attention: Maintenez une distance d'au moins 150 mm des murs
Achtung: Abstand von mindestens 150 mm zu den Wänden einhalten
Atención: mantenga una distancia de al menos 150 mm de las paredes

Gas Art		
Erdgas LL (Hi = 8,13 KWh/mc) m³/h	Nennwärmebelastung 1,10	Kleinstellung 0,61
Erdgas E (Hi = 9,45 KWh/mc) m³/h	Nennwärmebelastung 0,95	Kleinstellung 0,53
Flüssiggas (Hi = 12,68 KWh/Kg) Kg/h	Nennwärmebelastung 0,71	Kleinstellung 0,39
Düsen (Ø in 1/100 mm)		
Erdgas LL 20 mbar	Hauptbrenner 240 Zündbrenner 35	Kleinstellung Einstellbar
Erdgas E 20 mbar	Hauptbrenner 220 Zündbrenner 35	Kleinstellung 250
Flüssiggas 50 mbar	Hauptbrenner 130 Zündbrenner 20	Kleinstellung 110
Primärluft Abstand X		
Erdgas LL	Fest	
Erdgas E	Fest	
Flüssiggas	4	



G-20P

Info tecnica
 Technical info
 Infos techniques
 Technische Info
 Info técnica

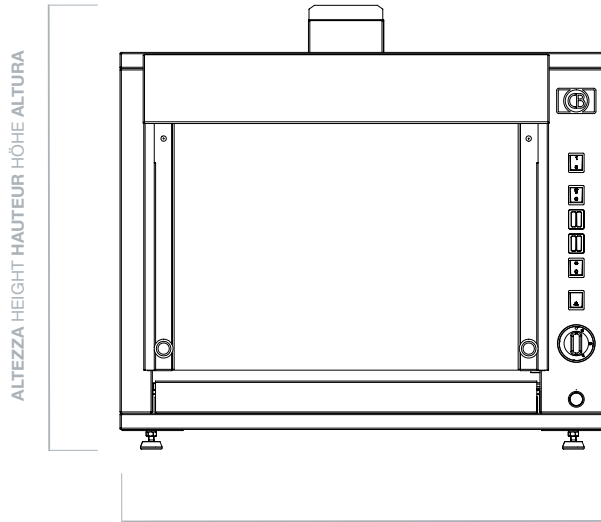

LARGHEZZA WIDTH LARGEUR BREITE ANCHURA

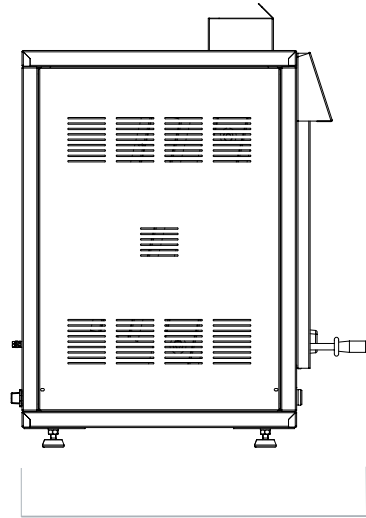

PROFONDITÀ DEPTH PROFONDEUR TIEFE PROFUNDIDAD

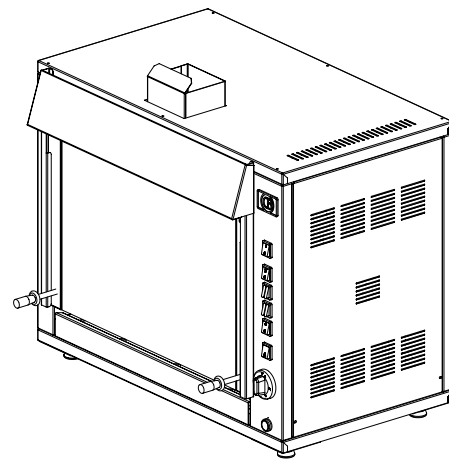
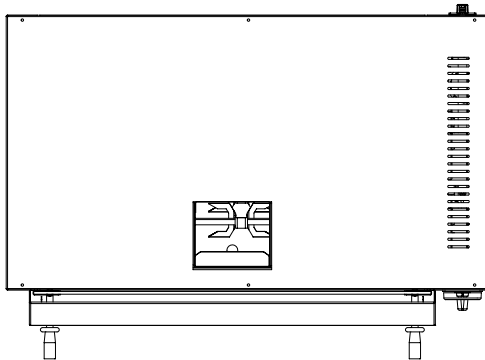

Modello Model Modèle Modell Modelo	Aste Spits Broches Spieße Espadas	Polli Chickens Poulets Hähnchen Pollos	Larghezza Width Largeur Breite Anchura	Profondità Depth Profondeur Tiefe Profundidad	Altezza Height Hauteur Höhe Altura	Altezza con vetro alzato Height with lifted glass Hauteur avec vitre soulevée Höhe mit Scheibe oben Altura con cristal elevado	Tensione Voltage Tension Spannung Voltaje	Portata Termica Thermic Capacity Débit calorifique Nennwärmebelastung Capacidad térmica	Potenza Power Puissance Leistung Potencia	Peso Weight Poids Gewicht Peso
G-20P	5	20(20 Kg)	900 mm	510 mm	780 mm	1030 mm	230V~	10 KW	170 W	Kg 73